

CIRQUE DU SOLEIL

SAUDI 88TH NATIONAL DAY

King Fahd Int Stadium
Riyadh
September 2018

A build overview and technical
information guide.

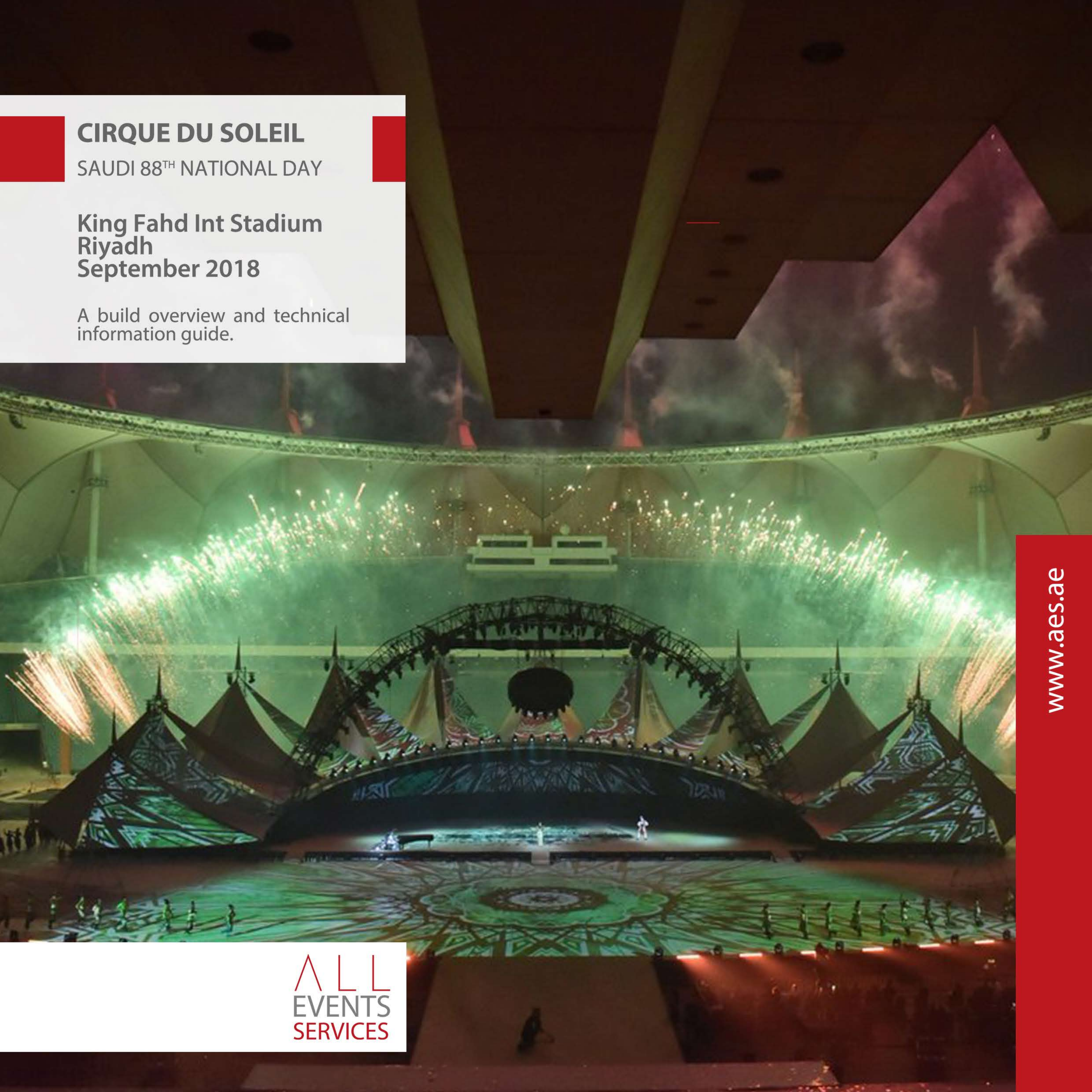

www.aes.ae

ALL
EVENTS
SERVICES



One of the largest ever single productions by Cirque Du Soleil

AES raised the bar early in the 2018 event season by supplying a full structural turnkey solution for the world famous Cirque du Soleil, in one of Saudi Arabia's biggest ever live shows.

Those who reside in the Middle East will know the importance of the National Day celebration, as it praises the nations' heritage, customs and traditions. The Kingdom of Saudi Arabia commemorated their 88th National Day on 23rd September and, they did it with style and grandeur.

With many events organised across the whole region, the General Entertainment Authority along with the MBC Group, produced the country's showcase event in the kingdom's capital Riyadh, performed in the King Fahd International Stadium.

The Montreal based Cirque du Soleil produced a customised performance for the Riyadh event, as opposed to a touring show. The hour-long spectacle featured more than 80 artists/performers, male and female, wearing 250 different costumes. Making it one of the largest productions ever created for a single performance by Cirque du Soleil.

Concept drawing of the 3,750 sq.m half moon stage with 11 steel towers

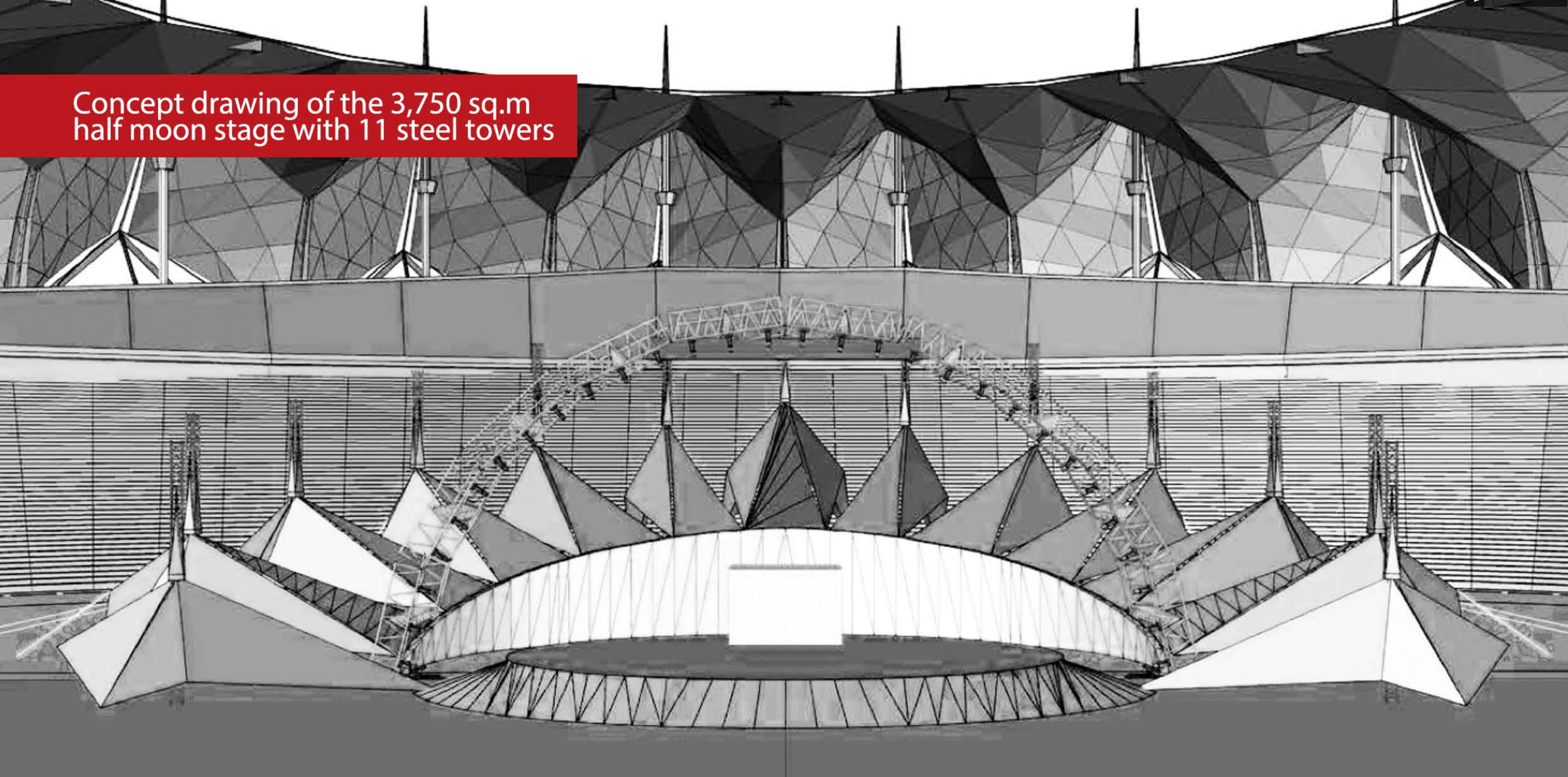

All Events Services were contracted to supply:

A gigantic 3,750 sq.m half crescent moon stage with 20m ramp.

A raised and reinforced main stage approx. 670 sq.m.

2 x 16m high IMAG towers to support aerial performers, projection fabric and AV.

11 x steel towers up to 15m to support the shaped fabric backdrop of the stage

4 x 16m high technical towers for the shows projection and lighting teams

2 x follow spot towers

875sqm of trackway flooring

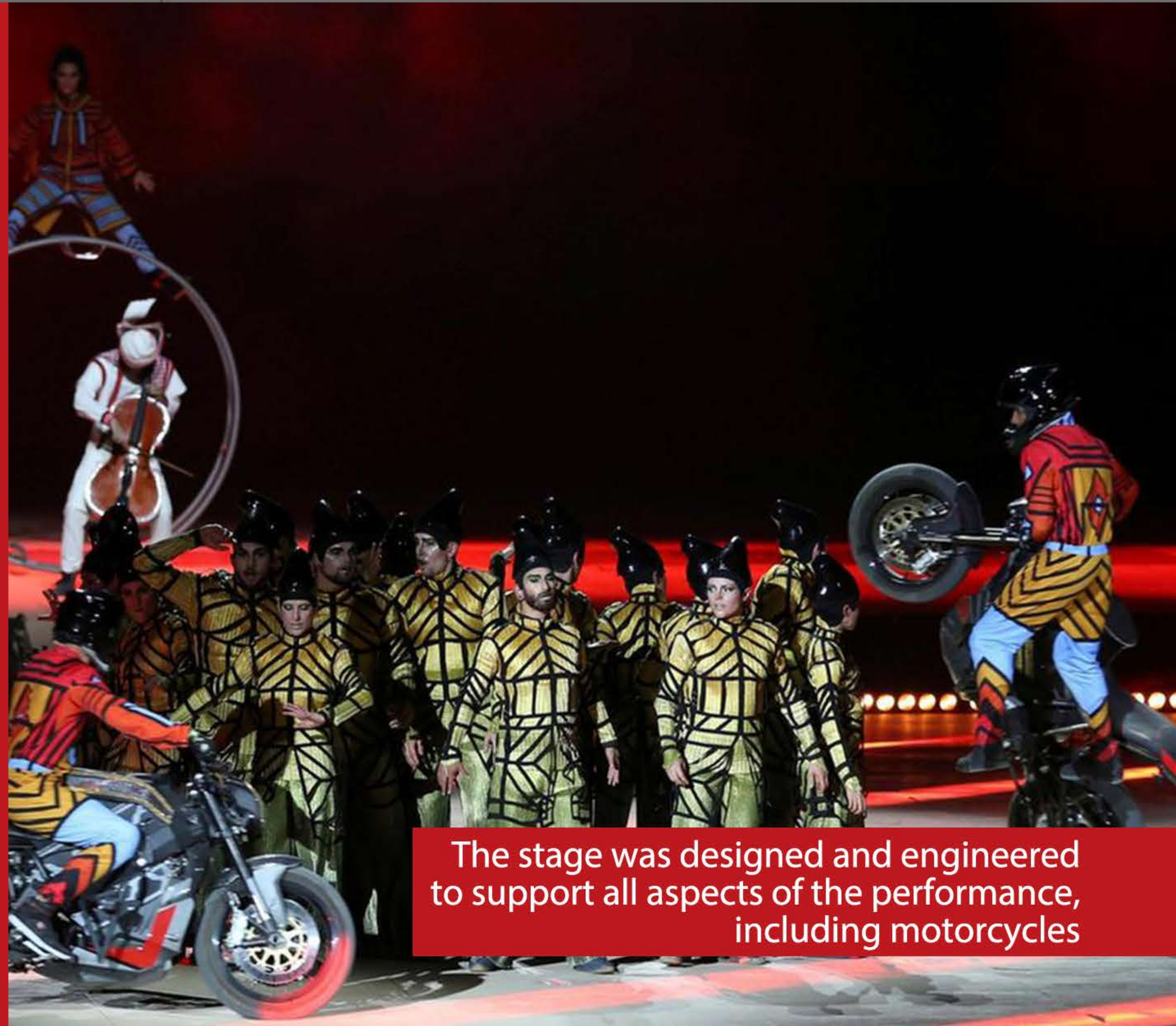

The stage was designed and engineered to support all aspects of the performance, including motorcycles



Stage, IMAG towers & Shade canopy tower build

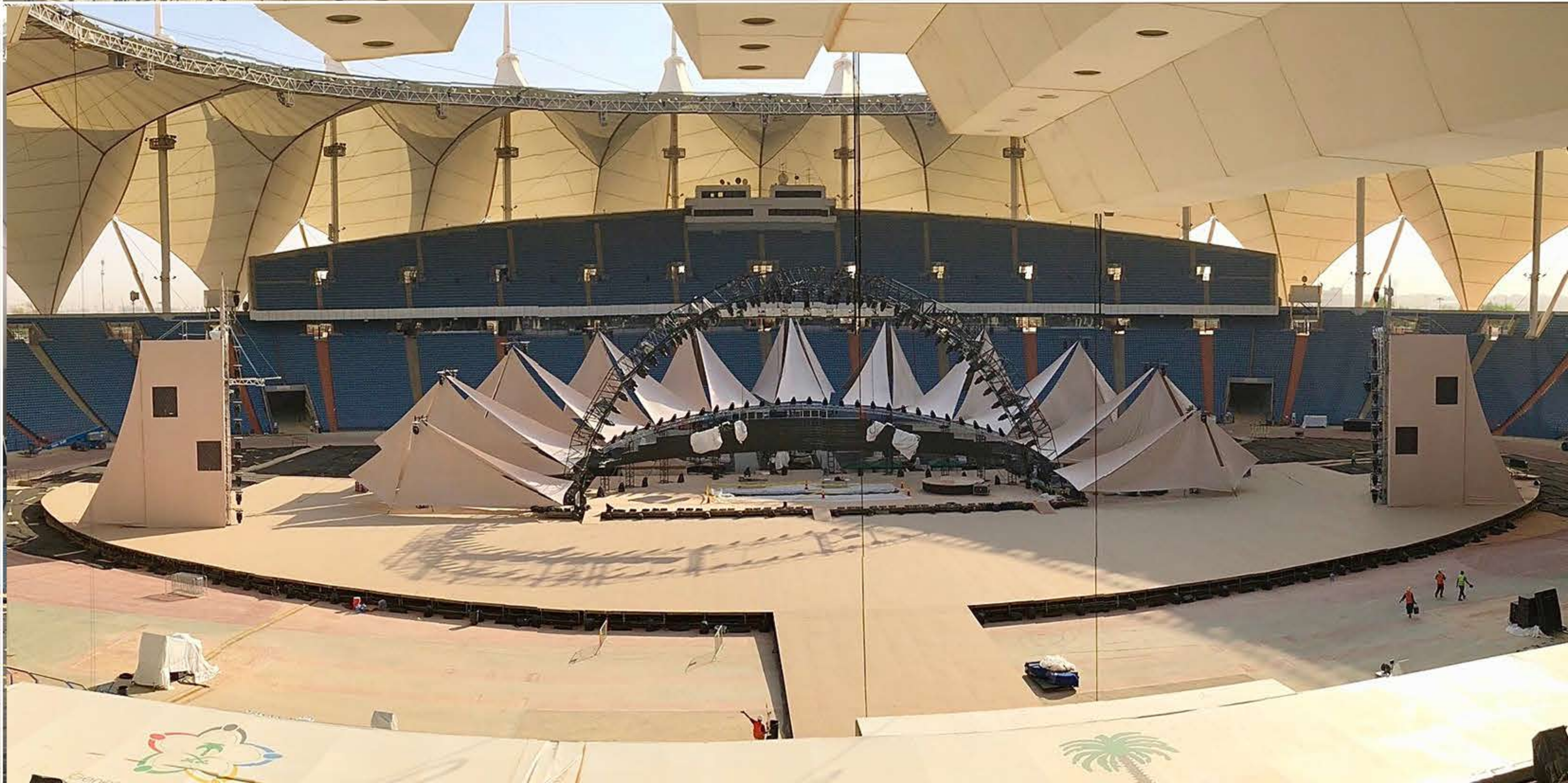
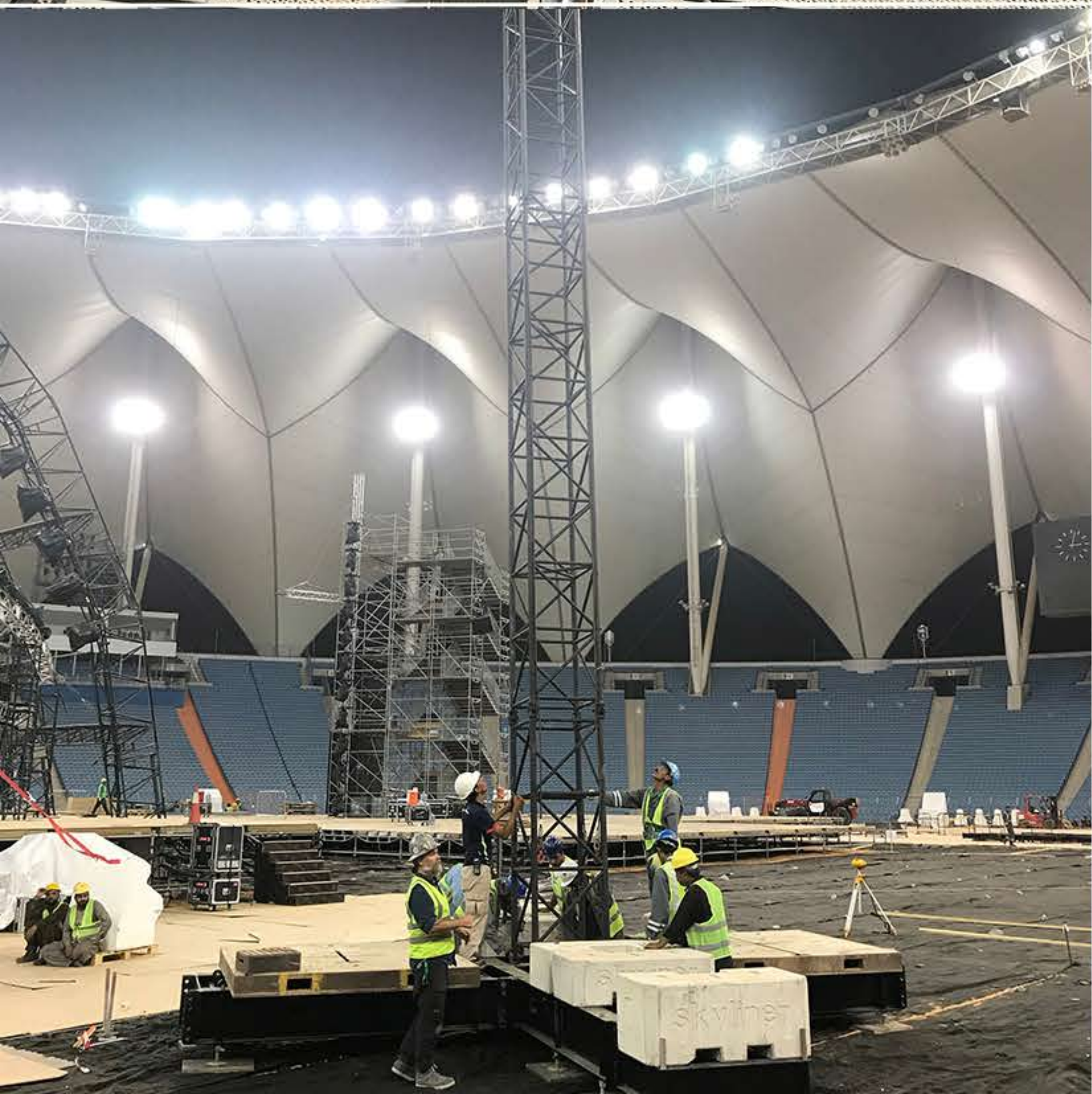
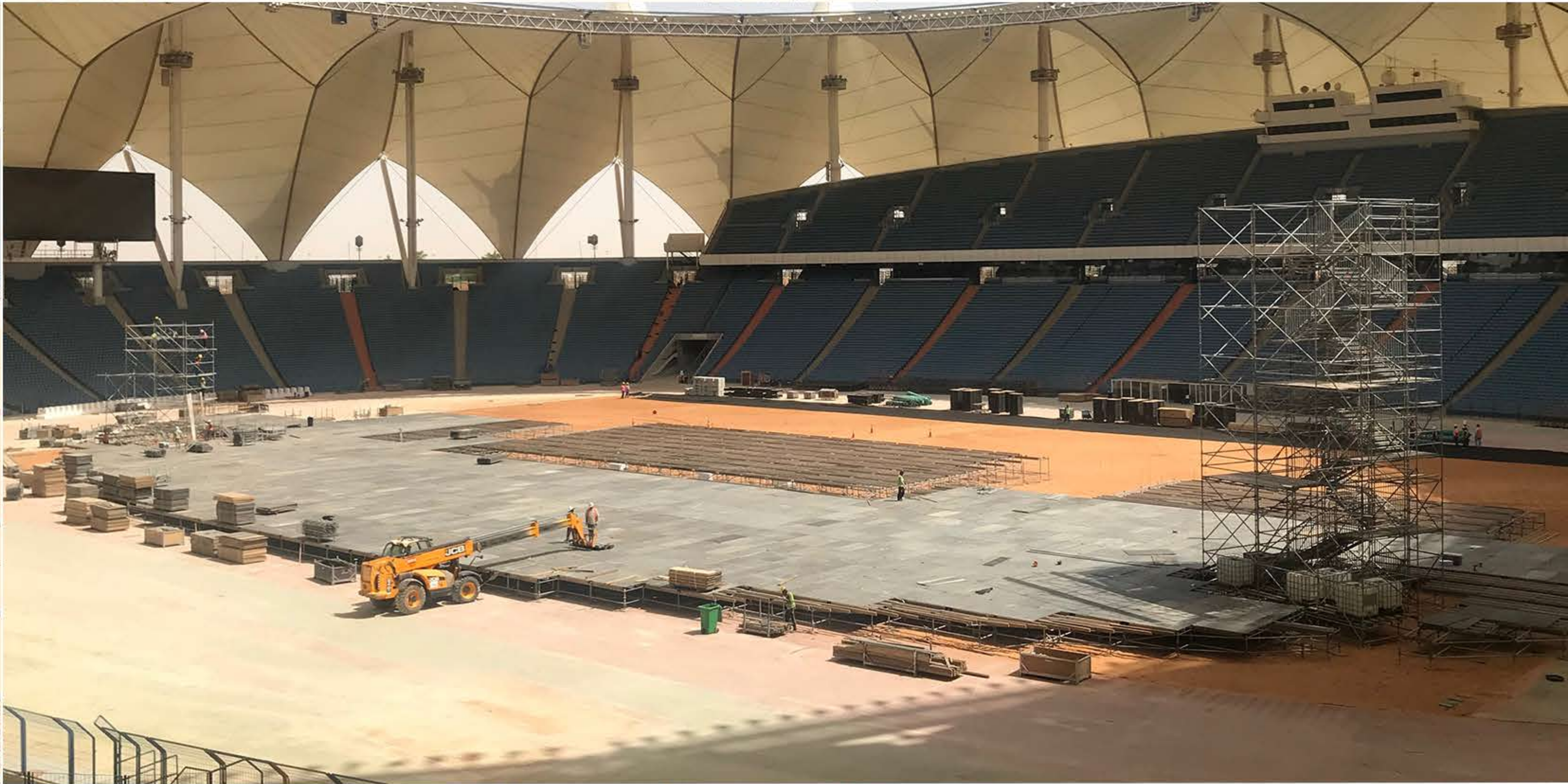

**2015 - UAE 44th National Day
celebration, Zayed Sports City
Stadium, Abu Dhabi**



**Experience from 2015 previous large scale staging project in UAE assisted AES
with the planning of the Cirque Du Soleil stage in 2018.**

**In 2015, the Abu Dhabi scaffold stage covered the full stadium pitch, over
10,000 sq.m.**

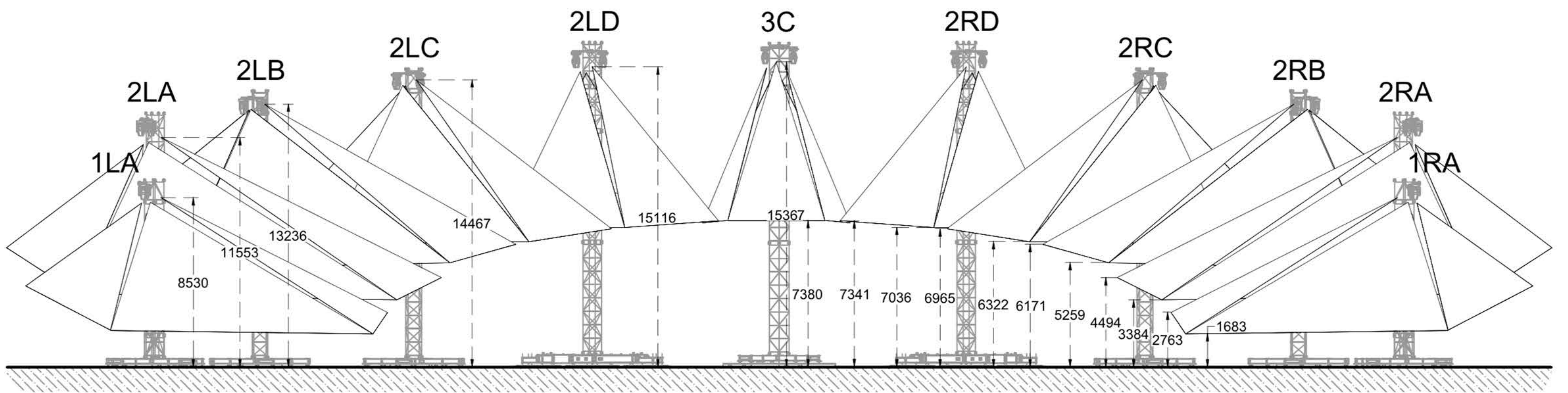

Black Steel Towers

AES supplied 11 black steel towers, which supported the large fabric canopies and lights that encircled the rear of the main stage.

The towers were setup at various heights, 5.5m high at stage left & right and increased in height up-stage centre to 12.5m. Multiple steel wires were attached to the towers from ballast blocks on the ground. These wires created the spine support for each fabric, which was draped over, creating the dramatic canopy shape desired.

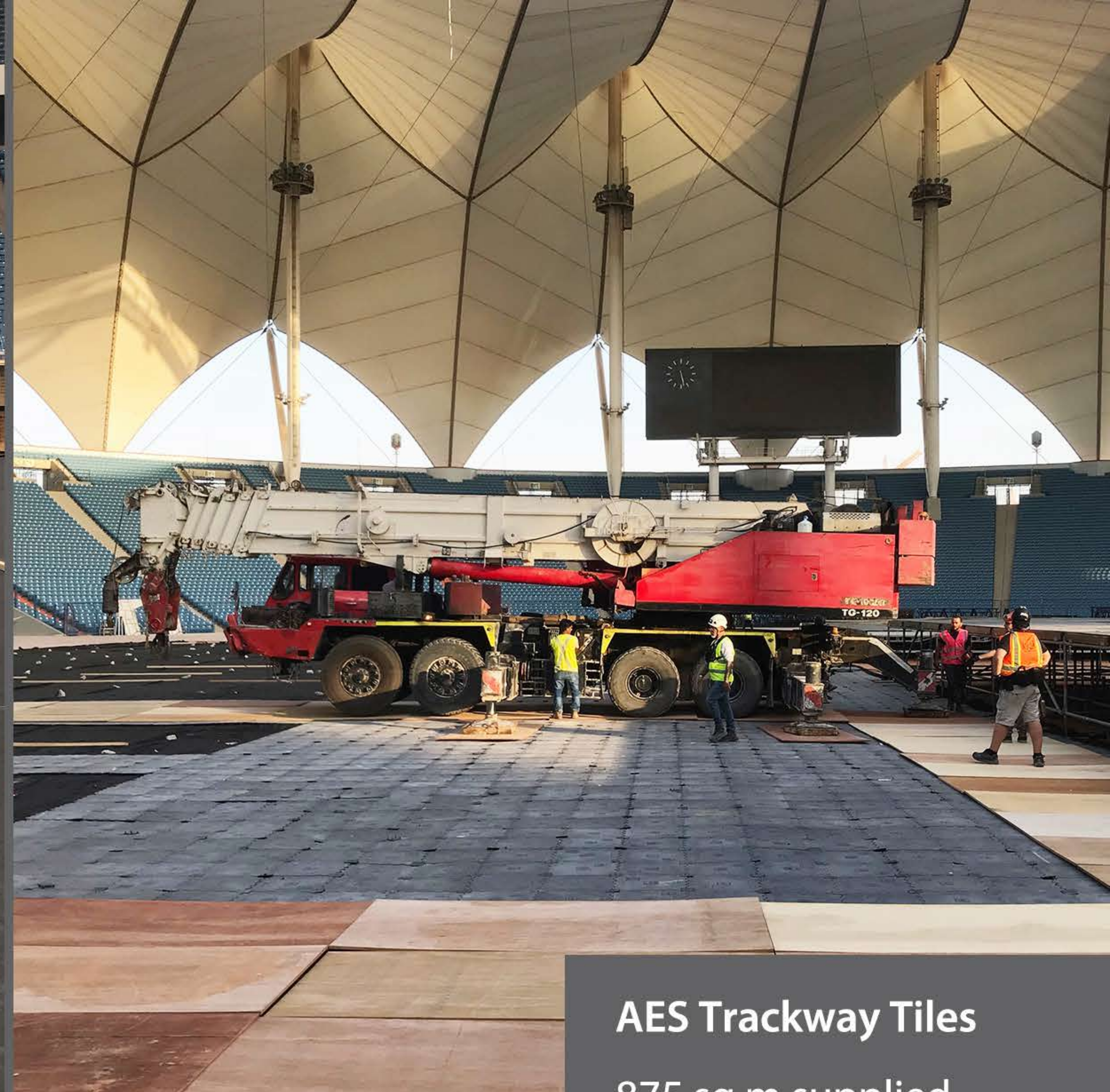
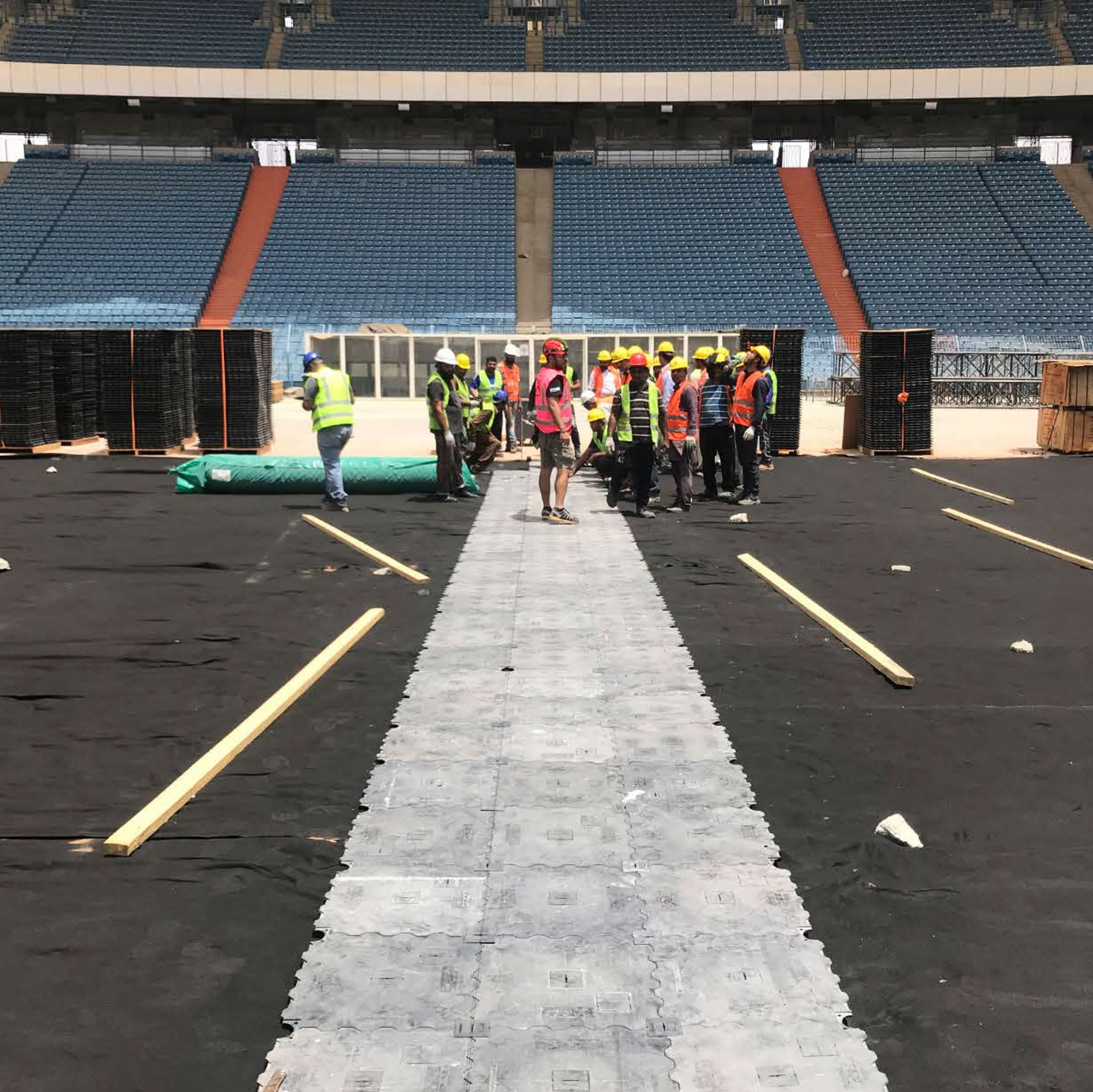

AES Trackway Tiles

875 sq.m supplied

20,000 kg load
capacity/per sq.m

Fixing sheet material
to top of the product
can also create
additional load
capacity

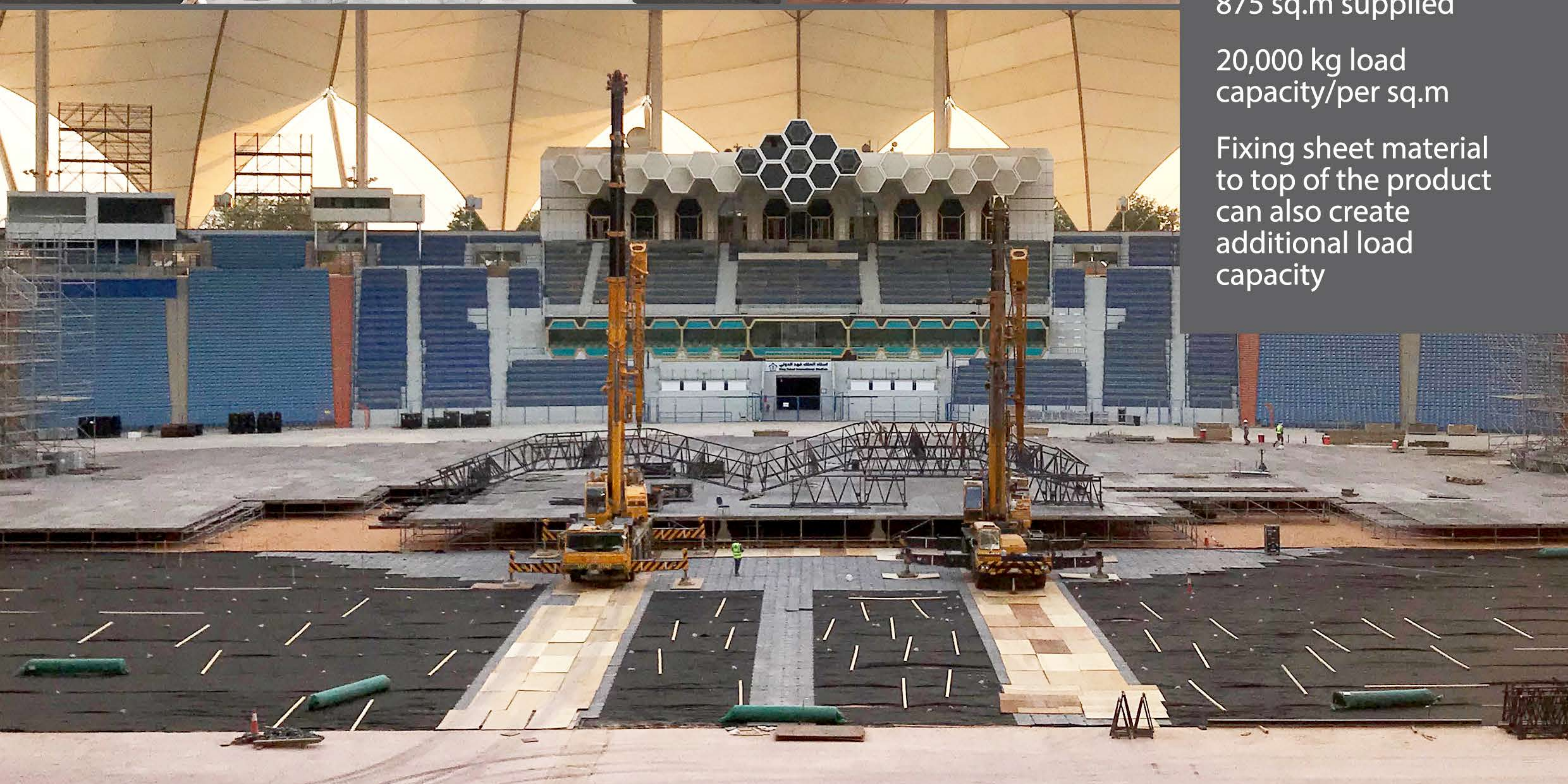



ALL
EVENTS
SERVICES

www.aes.ae info@aes.ae
(+971) 4 321 5599

Street 18, Al Quoz Industrial Area 1, 333986 P.O BOX
Dubai, United Arab Emirates